

Standard: CONNESSIONI LATERALI - SIDE PORTS - ANSCHLÜSSE SEITLICH

VALVOLE UNIDIREZIONALI INCORPORATE
BUILT-IN CHECK VALVES
EINGEBAUTE RÜCKSCHLAGVENTILE

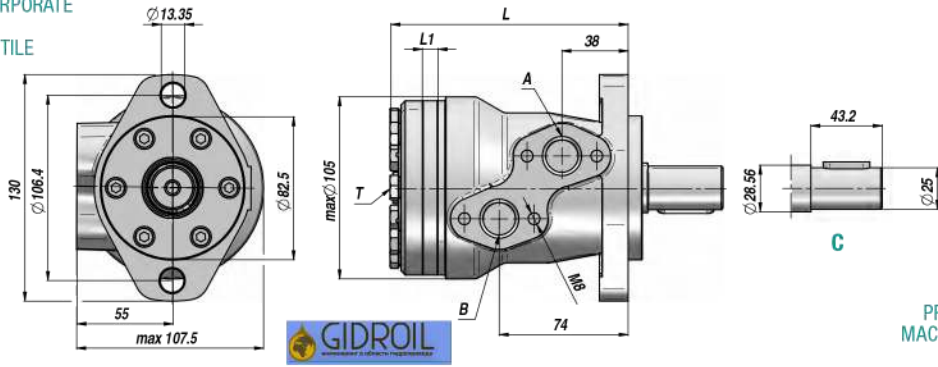

PREDISPOSTO PER IL DRENAGGIO
MACHINED FOR DRAIN CONNECTION
FÜR DRÄNLEITUNG GEEIGNET

Codice Code Bestell-Nr.	Tipo Type Typ	cm ³ /giro cm ³ /rev cm ³ /U	n. Max giri/min rpm - U/Min.	M Max daNm	Q MAX l/min	P MAX bar			A - B	T	L	L1	kg
						Caduta Drop Gefälle Δp	Ingresso Inlet Eingang	Ritorno Return Rücklauf					
LAVORO CONTINUO - CONTINUOUS WORK - DAUERARBEIT													
MSR050NC25	MPR 50 C	51,5	775	10,0	40	140	175	175 *			138	9,0	6,80
MSR080NC25	MPR 80 C	80,3	750	20,0	60	175	175	175 *			143	14,0	6,90
MSR100NC25	MPR 100 C	99,8	600	24,0	60	175	175	175 *			146	17,4	7,20
MSR125NC25	MPR 125 C	125,7	475	30,0	60	175	175	175 *			150,5	21,8	7,30
MSR160NC25	MPR 160 C	159,6	375	39,0	60	175	175	175 *	1/2"	1/4"	156,5	27,8	7,50
MSR200NC25	MPR 200 C	199,8	300	38,5	60	140	175	175 *			163,5	34,8	8,00
MSR250NC25	MPR 250 C	250,1	240	39,0	60	110	175	175 *			172	43,5	8,40
MSR315NC25	MPR 315 C	315,7	190	36,0	60	85	175	175 *			183	54,8	9,10
MSR400NC25	MPR 400 C	397,0	150	38,0	60	65	175	175 *			198	69,4	9,80

* = CON DRENAGGIO - WITH DRAIN - MIT DRÄNLEITUNG

OPTION

OPTION

OPTION

**PRESSIONE MAX. AL RITORNO SENZA DRENAGGIO
MAX. RETURN PRESSURE WITHOUT DRAIN
MAX GEGENDRUCK OHNE DRÄNLEITUNG**

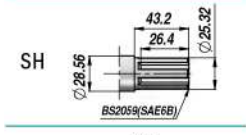
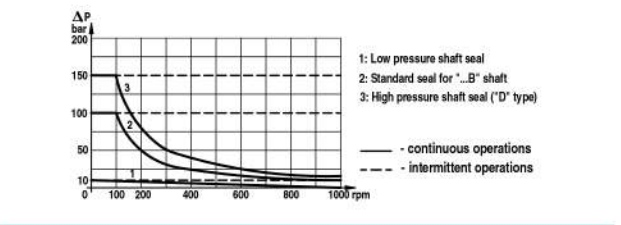
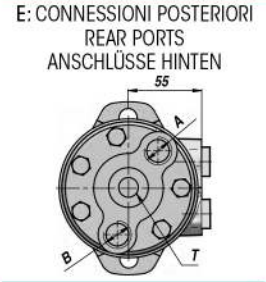
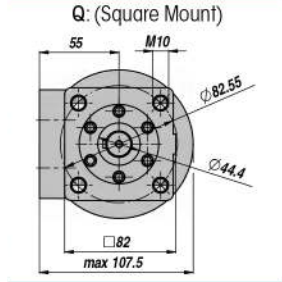
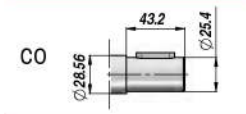

OPTION

OPTION

**CARICHI AMMESSI SULL'ALBERO
PERMISSIBLE SHAFT LOADS
ZULÄSSIGE WELLENBELASTUNGEN**

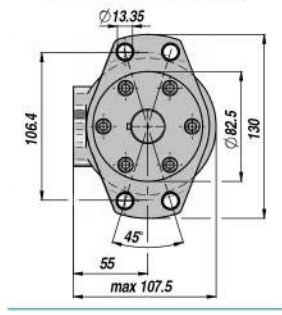
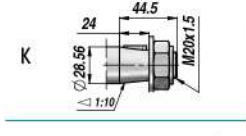

OPTION

OPTION

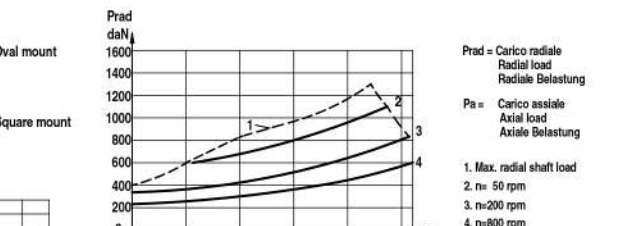
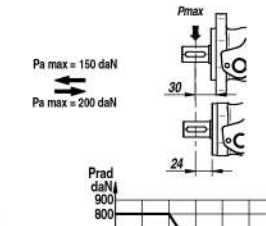
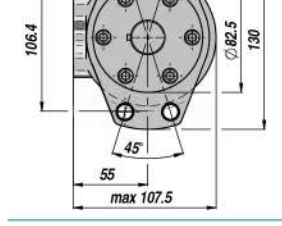
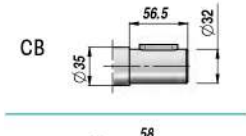

VERSIONI SPECIALI - SPECIAL VERSIONS - SPEZIELLE VERSIONEN

D: guarnizione albero - shaft seal - Wellendichtung; max 150 bar
N/D: con cuscinetti a rulli - with needle bearings - mit Rollenlagern
W: versione ruota - wheel mount - Radversion

